







Troubleshooting

-  **WARNING:** Do not use charging extensions with this product.
-  **WARNING:** Do not fit glands to the top of the product: this is associated with an increased risk of water ingress and potential electric shock.
-  **WARNING:** Do not use high-pressure washers to clean the Alpha7 Charger.
-  **WARNING:** Do not use high-pressure washers to clean the Alpha7 Charger.
-  **CAUTION:** Avoid positioning the installation in direct sunlight. Use only cabling suitable for EV installations.
-  **WARNING:** If the Alpha7 charger is damaged in any way, do not use it: contact Fast Amps to arrange a replacement unit.
-  **DANGER:** The applicable local and national wiring regulations must be adhered to during the installation and commissioning process.
-  **DANGER:** Read these instructions carefully before starting work. A failure to follow the instructions is likely to invalidate the warranty.
-  **DANGER:** Fast Amps very strongly recommends the use of an experienced and qualified installer who is aware of the local / national electrical wiring rules, specifically relating to EVs and charging requirements. Fast Amps will not accept liability for damage caused by incorrect installation.

Safety

4 x 38mm Screws

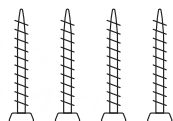

T20 Bit



4 x 40mm Wall Fixings

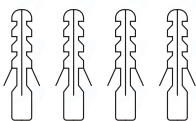

Alpha7 EV Charger

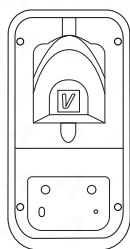



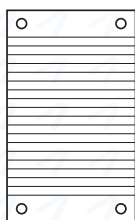



Box Insert: Mounting Template



Box Contents

Download the Fast Amps App

-  See Charge Status
-  Start or Stop Charging
-  See Charge History
-  Export Charge Data
-  Set Charge Times
-  Lock Your Charger



Scan to download the app

Your BlueTooth Password

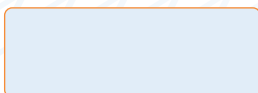

Have a question? We're here to help:

☎ 01743 249 900
@ info@fastamps.com

Darwin House, 2 The Mount, Shrewsbury, Shropshire, SY3 8PU

Company Registered in the UK: 13628447

VAT Registration Number: 390 4022 22



Scan to visit us at fastamps.com

FAST AMPS

SIMPLY RELIABLE

Alpha7 Generation 3

Untethered Quick Guide

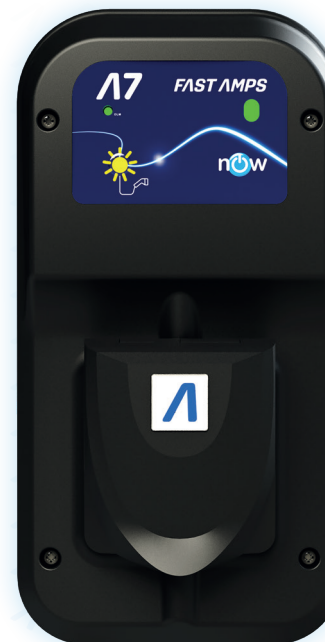

1. Drill Holes

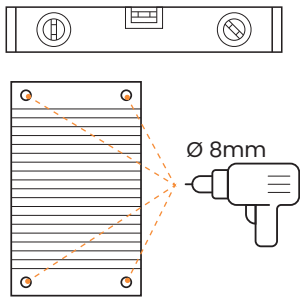

Use Mounting Template
! AVOID DIRECT SUNLIGHT !

2. Fit Glands

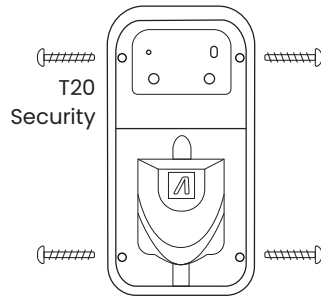

Remove Lid

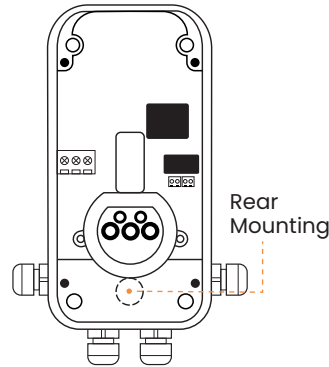

Allowed Drill Hole Gland Locations

3. Mounting

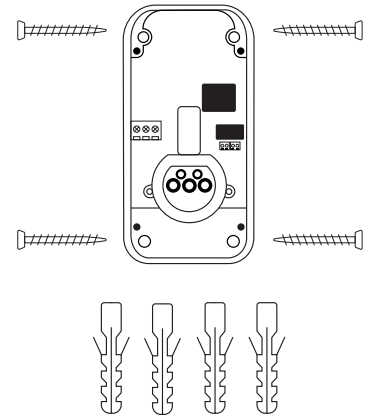

4. Set DIP Switch

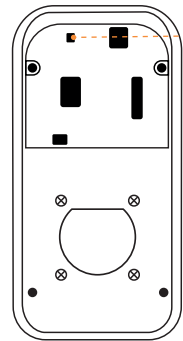

Comms Setting

ON	OFF	1	2	Bluetooth: BLE (Default)
OFF	ON	1	2	
ON	OFF	1	2	WiFi / Ethernet
OFF	ON	1	2	
ON	OFF	1	2	Bluetooth: BLE
OFF	ON	1	2	
ON	OFF	1	2	WiFi with OCPP
OFF	ON	1	2	

5. Wiring

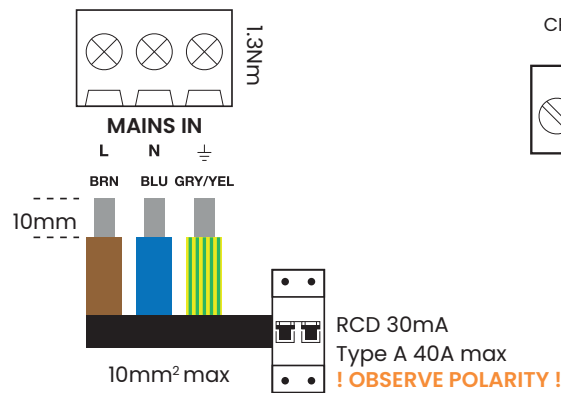

6. Pair App (Optional)

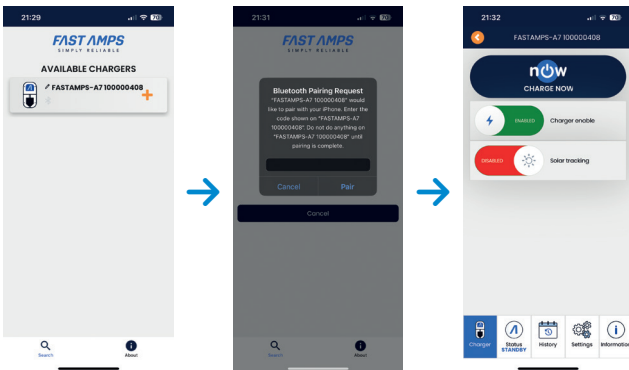

7. Set Current (optional)

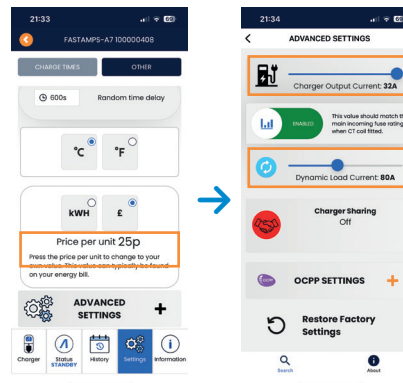

8. Re-assemble

Replace lid screws (2Nm)
Tighten Gland(s)

Charger Output Current (Default 32A)
Dynamic Load Current (Default "OFF")

9. Check

LED Indicator Colours

Blue	Ready to Charge
Blue Flash	Delay (0-600s/off-peak)
Green	Charging
Green Flash	Finished Charging
Yellow	Over Temperature
Yellow Flash	Lock Open / Close Error
Red	RCD/Relay Fault
Red Flash	Communication Error
Red Pulse	Mains Wiring Error
Red / Blue Flash	Mains Under Voltage
Red / Yellow Flash	Mains Over Voltage
Blue / Yellow Flash	Network Comms Error
Pink Flash	Over-current
White	Clock Error
White Flash	Battery Low
Multi-coloured	App Charger Lock

PRESS THE NOW BUTTON
Green LED = Charging



10. Charge

To begin charging, first unlock the vehicle and connect the cable to the vehicle's charging port then connect the cable to the Alpha7 unit.

If the LED indicator on the Alpha7 unit shows as green the vehicle is charging normally. If the LED is not green please refer to the chart in step 9 to diagnose the issue.

To stop charging, unlock the vehicle and disconnect the cable from the vehicle's charging port then disconnect the cable from the Alpha7 unit.